

# High Precision Tools for Watch Making

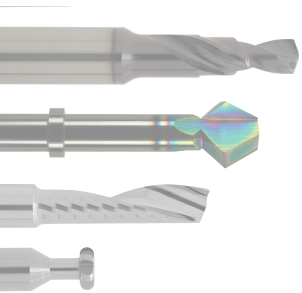

**Wide Range  
Customized Solution  
Coating Optimized for Micro Tools**



[www.axis-microtools.com](http://www.axis-microtools.com)



	NC Pointing Drill	Micro Drill	INDrill Universal	3Flute Drill	Spade Drill	Halfmoon Drill	Gun Drill	Step Drill	Clear Cut Drill (Sweep cut drill)	1F Endmill Helical	1F Endmill Straight Helix	2F Square Endmills	3F Square Endmills	4F Square Endmills	Inner Radius Cutter	Chamfering Cutter	Engraver	Engraver Reinforced	Thread Whirler	T-Slot Cutter
Article	T5811 / T5801 T1801	T6981	T6961	T0611	T2001	T9801	T5001	T5791	T5991	E9231	E9181	E9661	E9681	E9671	E9611	C6761	G8471	G6471	F5001/ F5011	F8101
Dia Range	0.020 - 3.00	0.05 - 1.50	0.020 - 3.00	0.150 - 12.50	0.10 - 6.00	0.50 - 6.00	0.10 / 2.00	0.50 - 16.00	0.50 - 16.00	0.10 - 16.00	0.10 - 16.00	0.080 - 16.00	1.00 - 16.00	0.20 - 16.00		0.20 - 12.00	0.03 / 3.00	0.03 / 3.00	2.00 / 3.00	2.00 / 12.00
Other Parameters															Radius 0.10 - 5.00		30° / 45°/ 60° / 90°/ 120°	30° / 45°/ 60° / 90°/ 120°		

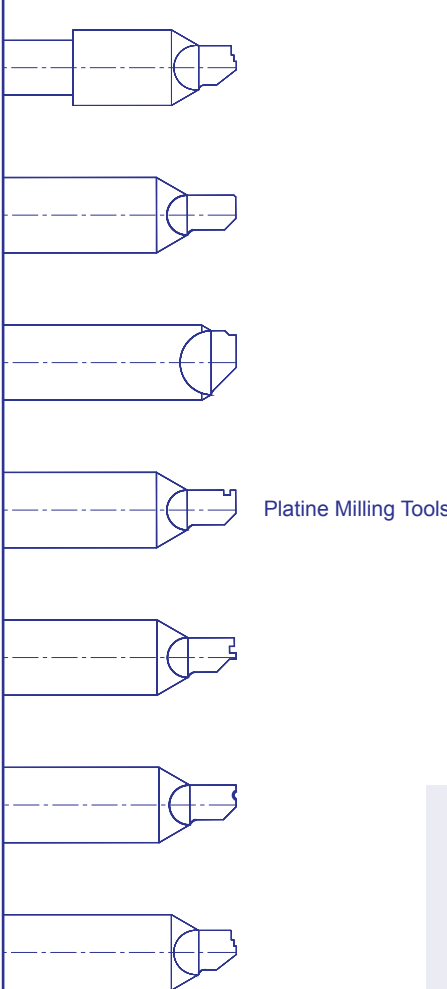

Platine Milling Tools



Platine



Watch Case



Watch Crown

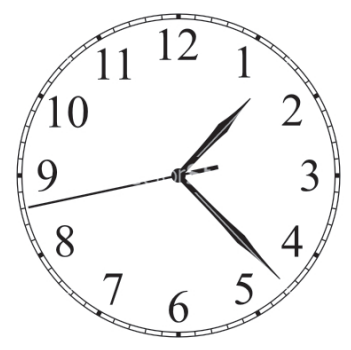

Dial

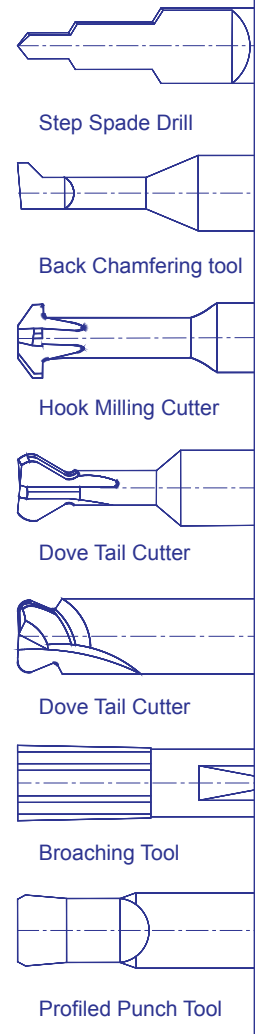

**Also available:**

Special Profile Tools, Form Tools, Micro Reamers,  
Micro Punches, Broach

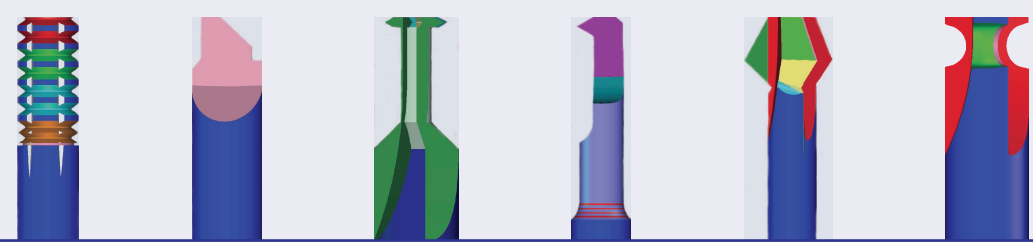

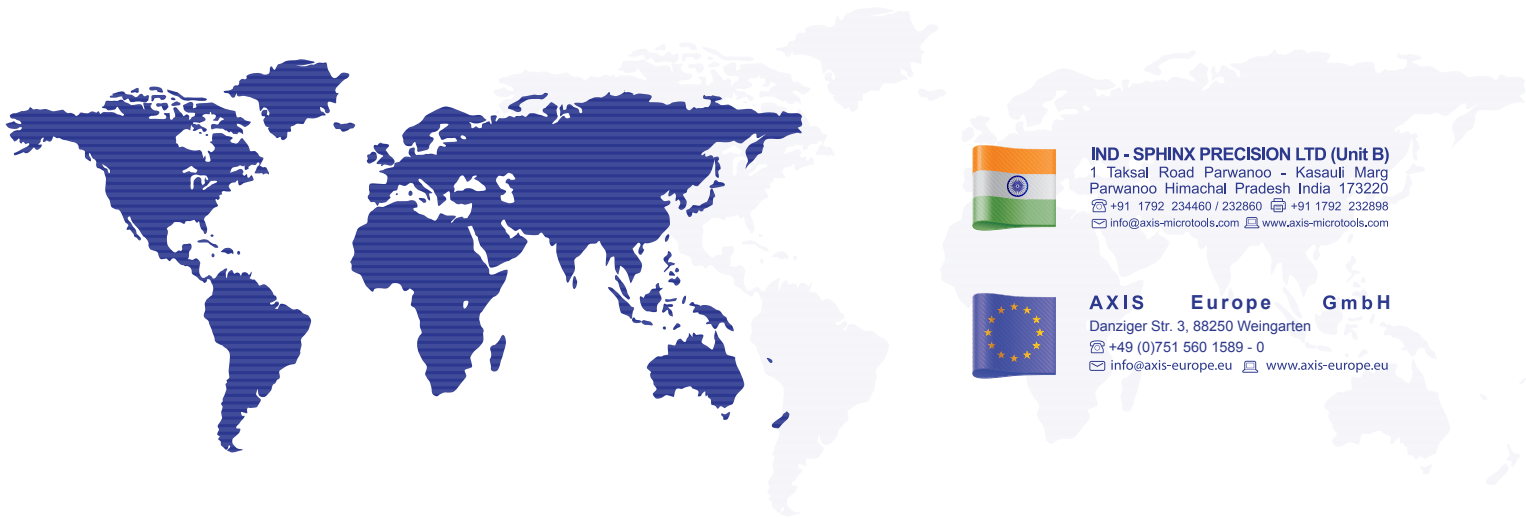
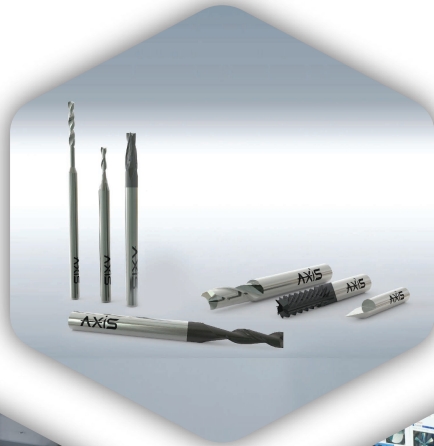

**IND - SPHINX PRECISION LTD (Unit B)**  
1 Taksal Road Parwanoo - Kasauli Marg  
Parwanoo Himachal Pradesh India 173220  
☎ +91 1792 234460 / 232860 ☎ +91 1792 232898  
✉ [info@axis-microtools.com](mailto:info@axis-microtools.com) 🌐 [www.axis-microtools.com](http://www.axis-microtools.com)



**AXIS Europe GmbH**  
Danziger Str. 3, 88250 Weingarten  
☎ +49 (0)751 560 1589 - 0  
✉ [info@axis-europe.eu](mailto:info@axis-europe.eu) 🌐 [www.axis-europe.eu](http://www.axis-europe.eu)

**AXIS**<sup>®</sup>  
Tools for **m**ICRO **m**ACHINING

